

POWERGEAR[®]

EUROPE

LIGHTING TRACK SYSTEMS

2021



ON THE RIGHT TRACK

Tailormade solutions

3-CIRCUIT TRACK SYSTEM	04
3-CIRCUIT DALI TRACK SYSTEM	10
1-CIRCUIT DALI TRACK SYSTEM	16
TRACK SUSPENSION & GENERAL ACCESSORIES	20
ADAPTERS & ULTIMATE ADAPTERS	26
48V TRACK SYSTEM	32
TECHNICAL DETAILS	40

Innovative

Cost effective

POWERGEAR[®]

EUROPE

Is a strong global brand in tailor made lighting track systems and universal adapters for the professional lighting market. Powergear offers a high quality 3 circuit (3-phase) lighting track system which is fully compatible with 3-phase adapters of all major brands. The comprehensive range of innovative accessories – like the twisted L and T connectors – gives the designer maximum freedom to create the ultimate track plan. To guarantee cost-effectiveness and flexibility, we make use of our own manufacturing facilities with our products being produced under certified ISO9001 and ISO14001 regulations and ENEC, CE and UL labels which are relevant for the European and/ or US market.

Customer service

From our European head office for sales, service and distribution we offer swift and efficient deliveries and strive to provide the highest level of customer service possible. The growing Powergear distribution centre network ensures availability throughout all European countries, making Powergear the winning brand in Lighting Track.

Flexible solutions

Due to our strong customer focus, Powergear is willing and able to offer flexible opportunities to fulfill the specific needs of a customer. From a fully customized product to our standard product and every step in between is part of the Powergear offer and service. This means that Powergear can offer a solution in own package or label of the customer, but also a complete private label concept. In general it means that we walk the extra mile to satisfy our customer.

High quality standards



*Maximum freedom to create
your ultimate trackplan*

3-CIRCUIT TRACK SYSTEM

Powergear's high quality 3-circuit track system for the professional lighting market is suitable for track lights with 3-circuit adapters of all major brands.

A comprehensive range of innovative accessories give designers maximum freedom to create unique track plans. For both surface mounted and recessed 3-circuit track the same accessories can be used.

The unique Powergear Twisted L and T connectors enable a quick and easy installation with less items to take care of.

Powergear track can be easily shortened and is immediately ready to install as there is no need to adjust wires. The "EZCLICK" mounting features make the track system quick and easy to install.

A new, innovative and competitive range of Powergear Ultimate adapters is at your disposal. As the LED driver is concealed in the adapter you can continue to miniaturize your track lights.

To make your 3-circuit system Bluetooth controllable, Powergear offers Ultimate adapters with Casambi technology.



SURFACE MOUNTED

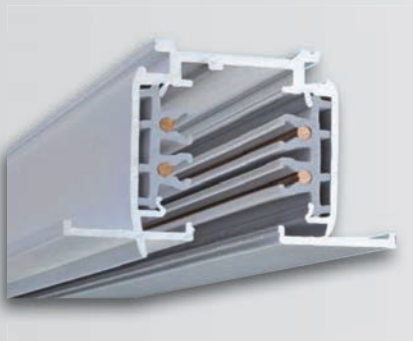
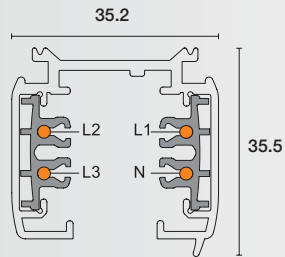

RECESSED

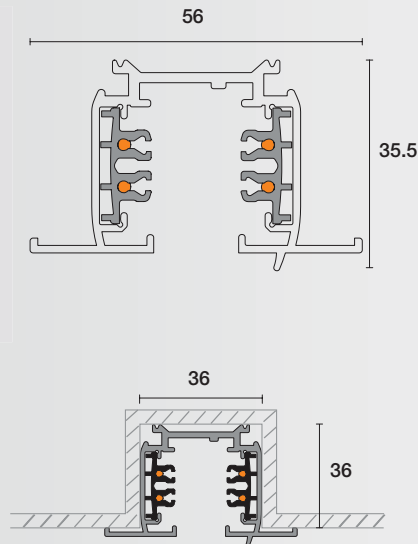

3-CIRCUIT SURFACE MOUNTED TRACK SYSTEM

Product Code	EAN	Product description	Colour	Package
PRO-0410-W	8719747930007	1 M track (1000mm)	<input type="checkbox"/> White	1 / 6
PRO-0410-S	8719747930014	1 M track (1000mm)	<input checked="" type="checkbox"/> Grey	1 / 6
PRO-0410-B	8719747930021	1 M track (1000mm)	<input checked="" type="checkbox"/> Black	1 / 6
PRO-0420-W	8719747930069	2 M track (2000mm)	<input type="checkbox"/> White	1 / 6
PRO-0420-S	8719747930076	2 M track (2000mm)	<input checked="" type="checkbox"/> Grey	1 / 6
PRO-0420-B	8719747930083	2 M track (2000mm)	<input checked="" type="checkbox"/> Black	1 / 6
PRO-0430-W	8719747930120	3 M track (3000mm)	<input type="checkbox"/> White	1 / 6
PRO-0430-S	8719747930137	3 M track (3000mm)	<input checked="" type="checkbox"/> Grey	1 / 6
PRO-0430-B	8719747930144	3 M track (3000mm)	<input checked="" type="checkbox"/> Black	1 / 6
PRO-0440-W	on request	4 M track (4000mm)	<input type="checkbox"/> White	1 / 6
PRO-0440-S	on request	4 M track (4000mm)	<input checked="" type="checkbox"/> Grey	1 / 6
PRO-0440-B	on request	4 M track (4000mm)	<input checked="" type="checkbox"/> Black	1 / 6

3-CIRCUIT RECESSED TRACK SYSTEM

Product Code	EAN	Product description	Colour	Package
PRO-R410-W	8719747931011	1 M track (1000mm)	<input type="checkbox"/> White	1 / 4
PRO-R410-S	8719747931028	1 M track (1000mm)	<input checked="" type="checkbox"/> Grey	1 / 4
PRO-R410-B	8719747931035	1 M track (1000mm)	<input checked="" type="checkbox"/> Black	1 / 4
PRO-R420-W	8719747931042	2 M track (2000mm)	<input type="checkbox"/> White	1 / 4
PRO-R420-S	8719747931059	2 M track (2000mm)	<input checked="" type="checkbox"/> Grey	1 / 4
PRO-R420-B	8719747931066	2 M track (2000mm)	<input checked="" type="checkbox"/> Black	1 / 4
PRO-R430-W	8719747931073	3 M track (3000mm)	<input type="checkbox"/> White	1 / 4
PRO-R430-S	8719747931080	3 M track (3000mm)	<input checked="" type="checkbox"/> Grey	1 / 4
PRO-R430-B	8719747931097	3 M track (3000mm)	<input checked="" type="checkbox"/> Black	1 / 4
PRO-R440-W	on request	4 M track (4000mm)	<input type="checkbox"/> White	1 / 4
PRO-R440-S	on request	4 M track (4000mm)	<input checked="" type="checkbox"/> Grey	1 / 4
PRO-R440-B	on request	4 M track (4000mm)	<input checked="" type="checkbox"/> Black	1 / 4

More technical details on page 40.

CONNECTOR LEFT



Product Code	EAN	Colour	Package
PRO-0431 L-W	8719747930212	White	12 / 144
PRO-0431 L-S	8719747930229	Grey	12 / 144
PRO-0431 L-B	8719747930236	Black	12 / 144



CONNECTOR RIGHT



Product Code	EAN	Colour	Package
PRO-0431 R-W	8719747930243	White	12 / 144
PRO-0431 R-S	8719747930250	Grey	12 / 144
PRO-0431 R-B	8719747930267	Black	12 / 144



COUPLER



Product Code	EAN	Colour	Package
PRO-0433-W	8719747930304	White	10 / 200
PRO-0433-S	8719747930311	Grey	10 / 200
PRO-0433-B	8719747930328	Black	10 / 200



COUPLER (INSULATION)



Product Code	EAN	Colour	Package
PRO-0433A-W	8719747930335	White	8 / 160
PRO-0433A-S	8719747930342	Grey	8 / 160
PRO-0433A-B	8719747930359	Black	8 / 160



MIDDLE CONNECTOR



Product Code	EAN	Colour	Package
PRO-0434-W	8719747930366	White	10 / 120
PRO-0434-S	8719747930373	Grey	10 / 120
PRO-0434-B	8719747930380	Black	10 / 120



END CAP



Product Code	EAN	Colour	Package
PRO-0432-W	8719747930274	White	15 / 300
PRO-0432-S	8719747930281	Grey	15 / 300
PRO-0432-B	8719747930298	Black	15 / 300



FLEXIBLE CONNECTOR



Product Code	EAN	Colour	Package
PRO-0439-W	8719747930601	White	14 / 70
PRO-0439-S	8719747930618	Grey	14 / 70
PRO-0439-B	8719747930625	Black	14 / 70



ADJUSTABLE CONNECTOR



Product Code	EAN	Colour	Package
PRO-M435-W	8719747930632	White	15 / 90
PRO-M435-S	8719747930649	Grey	15 / 90
PRO-M435-B	8719747930656	Black	15 / 90



X CONNECTOR



Product Code	EAN	Colour	Package
PRO-0437-W	8719747930571	White	5 / 60
PRO-0437-S	8719747930588	Grey	5 / 60
PRO-0437-B	8719747930595	Black	5 / 60



TWISTED T AND L CONNECTORS

Powergear Twisted T (and L) connectors enable maximum flexibility to create the ultimate trackplan with less connectors to use. And give the installer the freedom to change on the work spot. Simply unscrew the cover plate and change L1 into L2 or R1 into R2.

TWISTED T CONNECTOR

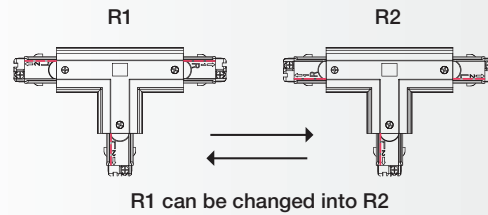
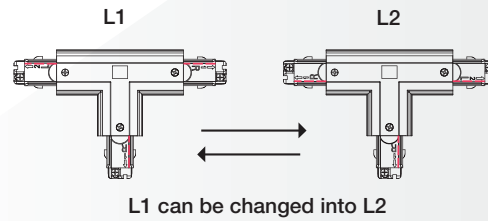
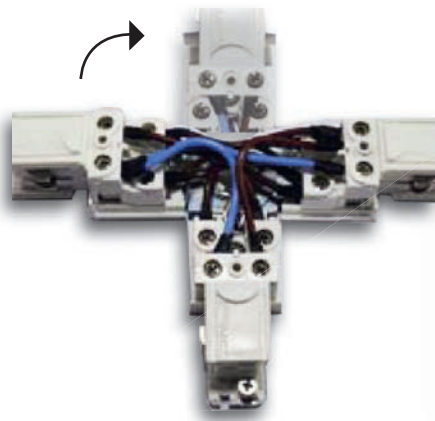

TWISTED L CONNECTOR

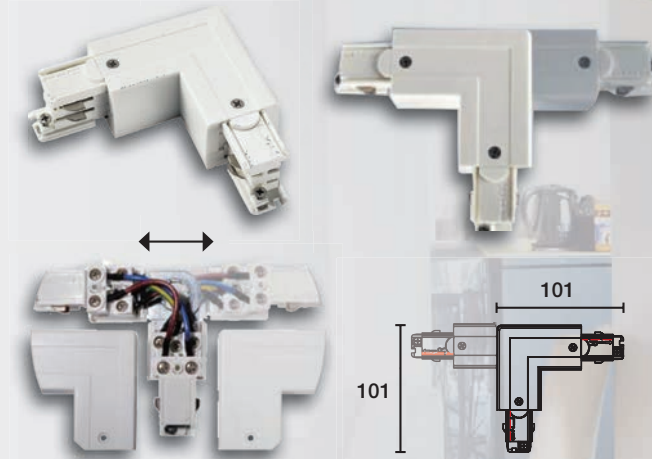

TWISTED L CONNECTOR (L AND R)

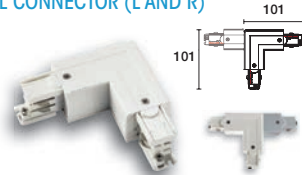

Product Code	EAN	Colour	Package
PRO-M438-W	8719747930663	White	18 / 108
PRO-M438-S	8719747930670	Grey	18 / 108
PRO-M438-B	8719747930687	Black	18 / 108



TWISTED T CONNECTOR L1 -> L2

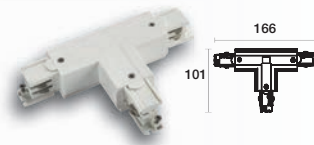

Product Code	EAN	Colour	Package
PRO-M436L-W	8719747930694	White	12 / 72
PRO-M436L-S	8719747930700	Grey	12 / 72
PRO-M436L-B	8719747930717	Black	12 / 72



TWISTED T CONNECTOR R1 -> R2

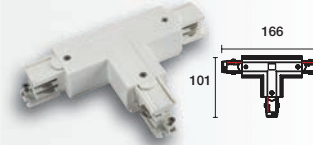

Product Code	EAN	Colour	Package
PRO-M436R-W	871974790724	White	12 / 72
PRO-M436R-S	871974790731	Grey	12 / 72
PRO-M436R-B	871974790748	Black	12 / 72



L CONNECTOR LEFT



Product Code	EAN	Colour	Package
PRO-0435 L-W	8719747930397	White	18 / 108
PRO-0435 L-S	8719747930403	Grey	18 / 108
PRO-0435 L-B	8719747930410	Black	18 / 108



L CONNECTOR RIGHT



Product Code	EAN	Colour	Package
PRO-0435 R-W	8719747930427	White	8 / 160
PRO-0435 R-S	8719747930434	Grey	8 / 160
PRO-0435 R-B	8719747930441	Black	8 / 160



T CONNECTOR LEFT1



Product Code	EAN	Colour	Package
PRO-0436 L1-W	8719747930458	White	12 / 72
PRO-0436 L1-S	8719747930465	Grey	12 / 72
PRO-0436 L1-B	8719747930472	Black	12 / 72



T CONNECTOR LEFT2



Product Code	EAN	Colour	Package
PRO-0436 L2-W	8719747930489	White	12 / 72
PRO-0436 L2-S	8719747930496	Grey	12 / 72
PRO-0436 L2-B	8719747930502	Black	12 / 72



T CONNECTOR RIGHT1



Product Code	EAN	Colour	Package
PRO-0436 R1-W	8719747930519	White	12 / 72
PRO-0436 R1-S	8719747930526	Grey	12 / 72
PRO-0436 R1-B	8719747930533	Black	12 / 72



T CONNECTOR RIGHT2

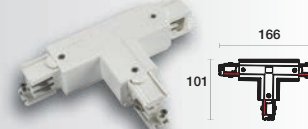

Product Code	EAN	Colour	Package
PRO-0436 R2-W	8719747930540	White	12 / 72
PRO-0436 R2-S	8719747930557	Grey	12 / 72
PRO-0436 R2-B	8719747930564	Black	12 / 72



X CONNECTOR COVER



Product Code	EAN	Colour	Package
PRO-R437-W	8719747931226	White	80 / 480
PRO-R437-S	8719747931233	Grey	80 / 480
PRO-R437-B	8719747931240	Black	80 / 480



MIDDLE CONNECTOR COVER



Product Code	EAN	Colour	Package
PRO-R434-W	8719747931134	White	40 / 480
PRO-R434-S	8719747931141	Grey	40 / 480
PRO-R434-B	8719747931158	Black	40 / 480



L CONNECTOR COVER



Product Code	EAN	Colour	Package
PRO-R435-W	8719747931165	White	25 / 500
PRO-R435-S	8719747931172	Grey	25 / 500
PRO-R435-B	8719747931189	Black	25 / 500



CONNECTOR COVER



Product Code	EAN	Colour	Package
PRO-R431-W	8719747931103	White	25 / 500
PRO-R431-S	8719747931110	Grey	25 / 500
PRO-R431-B	8719747931127	Black	25 / 500



T CONNECTOR COVER



Product Code	EAN	Colour	Package
PRO-R436-W	8719747931196	White	30 / 360
PRO-R436-S	8719747931202	Grey	30 / 360
PRO-R436-B	8719747931219	Black	30 / 360



*Make your Powergear lighting track
a smart Dali system*





SMART 3-CIRCUIT DALI TRACK SYSTEM

Powergear's high quality DALI 3-circuit track system for the professional lighting market is suitable for track lights with Powergear 3-circuit DALI adapters.

A comprehensive range of innovative DALI accessories give designers maximum freedom to create unique and smart track plans. The DALI accessories can be used for both surface mounted and recessed 3-phase DALI track.

Powergear DALI track can be easily shortened and is immediately ready to install as there is no need to adjust wires. The "EZCLICK" mounting features make the track system quick and easy to install.

A new, innovative and competitive range of Powergear Ultimate DALI adapters is at your disposal. As the DALI LED driver is concealed in the adapter you can continue to miniaturize your track lights.

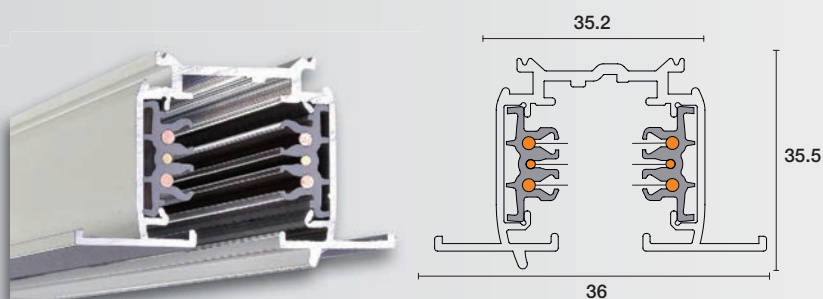
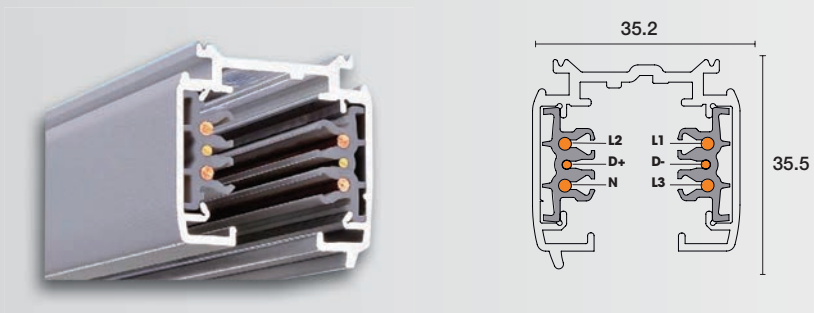

More technical details on page 41.

3-CIRCUIT DALI SURFACE MOUNTED TRACK SYSTEM

Product Code	EAN	Product description	Colour	Package
PRO-0610-W	8719747931257	1 M DALI track (1000mm)	<input type="checkbox"/> White	1 / 6
PRO-0610-S	8719747931264	1 M DALI track (1000mm)	<input type="checkbox"/> Grey	1 / 6
PRO-0610-B	8719747931271	1 M DALI track (1000mm)	<input type="checkbox"/> Black	1 / 6
PRO-0620-W	8719747931288	2 M DALI track (2000mm)	<input type="checkbox"/> White	1 / 6
PRO-0620-S	8719747931295	2 M DALI track (2000mm)	<input type="checkbox"/> Grey	1 / 6
PRO-0620-B	8719747931301	2 M DALI track (2000mm)	<input type="checkbox"/> Black	1 / 6
PRO-0630-W	8719747931318	3 M DALI track (3000mm)	<input type="checkbox"/> White	1 / 6
PRO-0630-S	8719747931325	3 M DALI track (3000mm)	<input type="checkbox"/> Grey	1 / 6
PRO-0630-B	8719747931332	3 M DALI track (3000mm)	<input type="checkbox"/> Black	1 / 6
PRO-0640-W	on request	4 M DALI track (4000mm)	<input type="checkbox"/> White	1 / 6
PRO-0640-S	on request	4 M DALI track (4000mm)	<input type="checkbox"/> Grey	1 / 6
PRO-0640-B	on request	4 M DALI track (4000mm)	<input type="checkbox"/> Black	1 / 6

3-CIRCUIT DALI RECESSED TRACK SYSTEM

Product Code	EAN	Product description	Colour	Package
PRO-R610-W	8719747931738	1 M DALI track (1000mm) recessed	<input type="checkbox"/> White	1 / 4
PRO-R610-S	8719747931745	1 M DALI track (1000mm) recessed	<input type="checkbox"/> Grey	1 / 4
PRO-R610-B	8719747931752	1 M DALI track (1000mm) recessed	<input type="checkbox"/> Black	1 / 4
PRO-R620-W	8719747931769	2 M DALI track (2000mm) recessed	<input type="checkbox"/> White	1 / 4
PRO-R620-S	8719747931776	2 M DALI track (2000mm) recessed	<input type="checkbox"/> Grey	1 / 4
PRO-R620-B	8719747931783	2 M DALI track (2000mm) recessed	<input type="checkbox"/> Black	1 / 4
PRO-R630-W	8719747931790	3 M DALI track (3000mm) recessed	<input type="checkbox"/> White	1 / 4
PRO-R630-S	8719747931806	3 M DALI track (3000mm) recessed	<input type="checkbox"/> Grey	1 / 4
PRO-R630-B	8719747931813	3 M DALI track (3000mm) recessed	<input type="checkbox"/> Black	1 / 4
PRO-R640-W	on request	4 M DALI track (4000mm)	<input type="checkbox"/> White	1 / 4
PRO-R640-S	on request	4 M DALI track (4000mm)	<input type="checkbox"/> Grey	1 / 6
PRO-R640-B	on request	4 M DALI track (4000mm)	<input type="checkbox"/> Black	1 / 6

CONNECTOR LEFT DALI 3-CIRCUIT



Product Code	EAN	Colour	Package
PRO-D631 L-W	8719747931370	White	10 / 120
PRO-D631 L-S	8719747931387	Grey	10 / 120
PRO-D631 L-B	8719747931394	Black	10 / 120



CONNECTOR RIGHT DALI 3-CIRCUIT



Product Code	EAN	Colour	Package
PRO-D631 R-W	8719747931400	White	10 / 120
PRO-D631 R-S	8719747931417	Grey	10 / 120
PRO-D631 R-B	8719747931424	Black	10 / 120



COUPLER DALI 3-CIRCUIT



Product Code	EAN	Colour	Package
PRO-D633-W	8719747931431	White	10 / 180
PRO-D633-S	8719747931448	Grey	10 / 180
PRO-D633-B	8719747931455	Black	10 / 180



MIDDLE CONNECTOR DALI 3-CIRCUIT



Product Code	EAN	Colour	Package
PRO-D634-W	8719747931462	White	10 / 120
PRO-D634-S	8719747931479	Grey	10 / 120
PRO-D634-B	8719747931486	Black	10 / 120



END CAP



Product Code	EAN	Colour	Package
PRO-0432-W	8719747930274	White	15 / 300
PRO-0432-S	8719747930281	Grey	15 / 300
PRO-0432-B	8719747930298	Black	15 / 300



FLEXIBLE CONNECTOR DALI 3-CIRCUIT



Product Code	EAN	Colour	Package
PRO-D639-W	8719747931554	White	12 / 60
PRO-D639-S	8719747931561	Grey	12 / 60
PRO-D639-B	8719747931578	Black	12 / 60



X CONNECTOR DALI 3-CIRCUIT

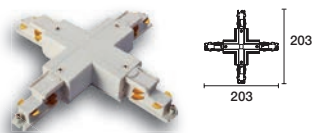

Product Code	EAN	Colour	Package
PRO-D637-W	8719747931585	White	2 / 24
PRO-D637-S	8719747931592	Grey	2 / 24
PRO-D637-B	8719747931608	Black	2 / 24



L CONNECTOR DALI LEFT 3-CIRCUIT



Product Code	EAN	Colour	Package
PRO-D635 L-W	8719747931493	White	12 / 60
PRO-D635 L-S	8719747931509	Grey	12 / 60
PRO-D635 L-B	8719747931516	Black	12 / 60



L CONNECTOR DALI RIGHT 3-CIRCUIT



Product Code	EAN	Colour	Package
PRO-D635 R-W	8719747931523	White	12 / 60
PRO-D635 R-S	8719747931530	Grey	12 / 60
PRO-D635 R-B	8719747931547	Black	12 / 60



T CONNECTOR DALI LEFT1 3-CIRCUIT

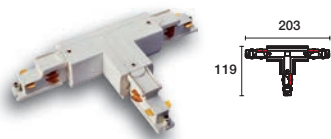

Product Code	EAN	Colour	Package
PRO-D636 L1-W	8719747931646	White	9 / 54
PRO-D636 L1-S	8719747931653	Grey	9 / 54
PRO-D636 L1-B	8719747931660	Black	9 / 54



T CONNECTOR DALI LEFT2 3-CIRCUIT



Product Code	EAN	Colour	Package
PRO-D636 L2-W	8719747931677	White	9 / 54
PRO-D636 L2-S	8719747931684	Grey	9 / 54
PRO-D636 L2-B	8719747931691	Black	9 / 54



T CONNECTOR DALI RIGHT1 3-CIRCUIT



Product Code	EAN	Colour	Package
PRO-D636 R1-W	8719747931707	White	9 / 54
PRO-D636 R1-W	8719747931714	Grey	9 / 54
PRO-D636 R1-W	8719747931721	Black	9 / 54



T CONNECTOR DALI RIGHT2 3-CIRCUIT



Product Code	EAN	Colour	Package
PRO-D636 R2-W	8719747931615	White	9 / 54
PRO-D636 R2-S	8719747931622	Grey	9 / 54
PRO-D636 R2-B	8719747931639	Black	9 / 54



CONNECTOR COVER

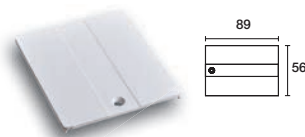

Product Code	EAN	Colour	Package
PRO-R631-W	8719747931820	White	40 / 480
PRO-R631-S	8719747931837	Grey	40 / 480
PRO-R631-B	8719747931844	Black	40 / 480



T CONNECTOR COVER



Product Code	EAN	Colour	Package
PRO-R436-W	8719747931196	White	30 / 360
PRO-R436-S	8719747931202	Grey	30 / 360
PRO-R436-B	8719747931219	Black	30 / 360



L CONNECTOR COVER



Product Code	EAN	Colour	Package
PRO-R435-W	8719747931165	White	25 / 500
PRO-R435-S	8719747931172	Grey	25 / 500
PRO-R435-B	8719747931189	Black	25 / 500



X CONNECTOR COVER



Product Code	EAN	Colour	Package
PRO-R437-W	8719747931226	White	80 / 480
PRO-R437-S	8719747931233	Grey	80 / 480
PRO-R437-B	8719747931240	Black	80 / 480



MIDDLE CONNECTOR COVER



Product Code	EAN	Colour	Package
PRO-R434-W	8719747931134	White	40 / 480
PRO-R434-S	8719747931141	Grey	40 / 480
PRO-R434-B	8719747931158	Black	40 / 480

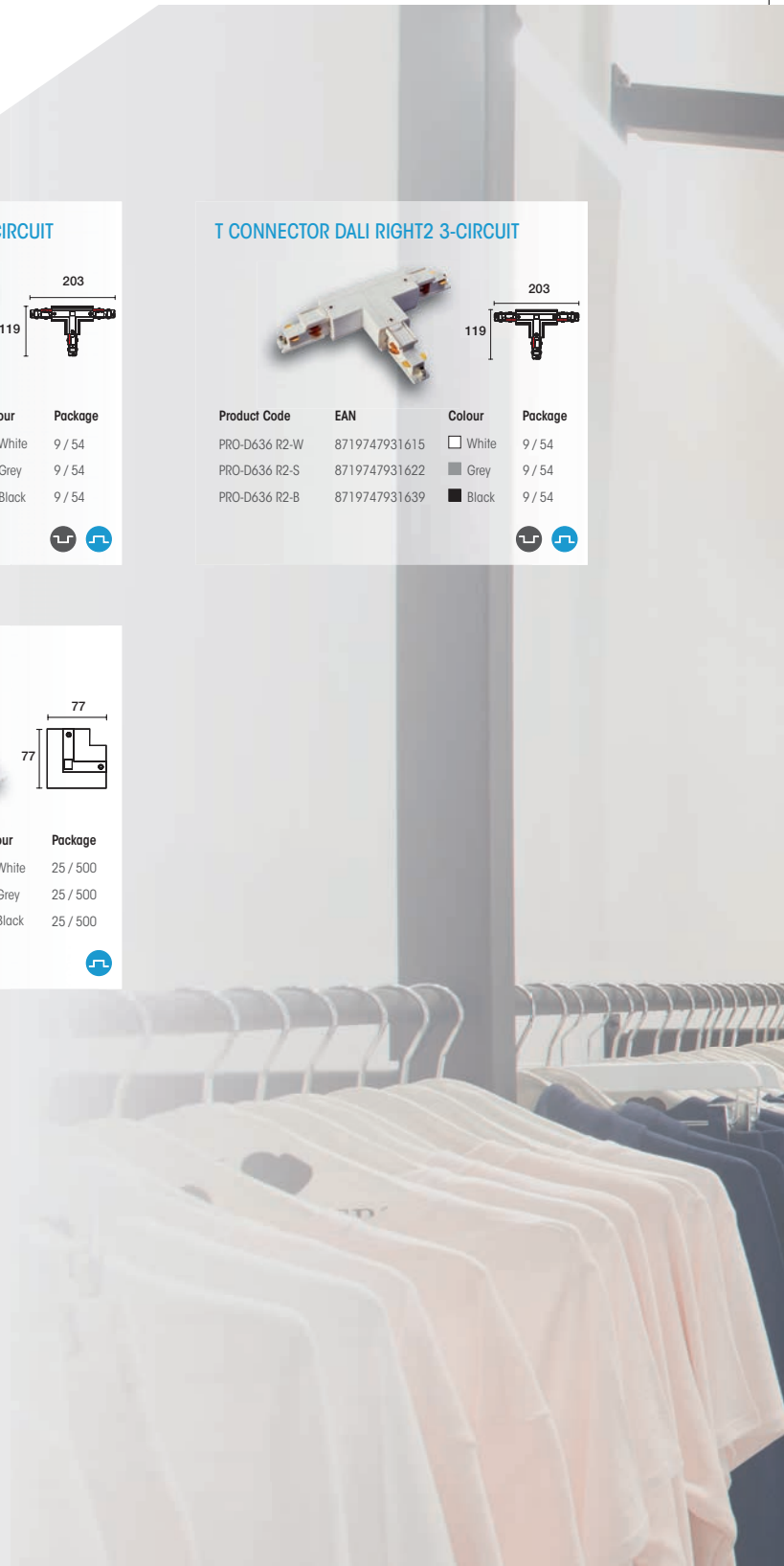





*Create your own Dali system
with standard 3-circuit track*

1-CIRCUIT DALI TRACK SYSTEM

Powergear 1-circuit DALI solutions helps customers to create their own DALI solution with a standard 3-circuit track.

Highly suitable when the track is not too comprehensive and the budget is limited.

Simply apply the comprehensive range of innovative DALI-1 circuit accessories and a standard track is turned into a DALI version.

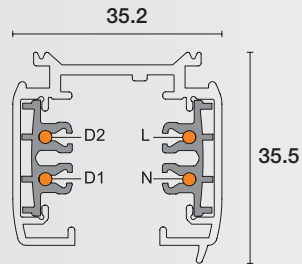

SURFACE MOUNTED

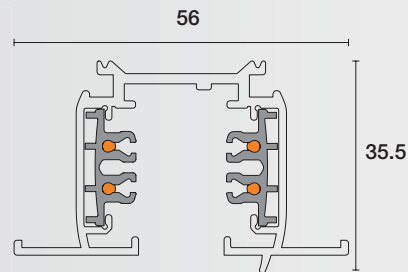
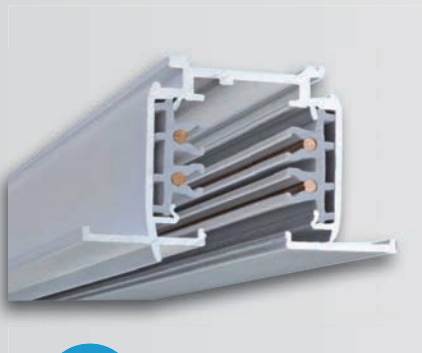

RECESSED

More technical details on page 42.

3-CIRCUIT SURFACE MOUNTED TRACK SYSTEM

Product Code	EAN	Product description	Colour	Package
PRO-0410-W	8719747930007	1 M track (1000mm)	<input type="checkbox"/> White	1 / 6
PRO-0410-S	8719747930014	1 M track (1000mm)	<input type="checkbox"/> Grey	1 / 6
PRO-0410-B	8719747930021	1 M track (1000mm)	<input type="checkbox"/> Black	1 / 6
PRO-0420-W	8719747930069	2 M track (2000mm)	<input type="checkbox"/> White	1 / 6
PRO-0420-S	8719747930076	2 M track (2000mm)	<input type="checkbox"/> Grey	1 / 6
PRO-0420-B	8719747930083	2 M track (2000mm)	<input type="checkbox"/> Black	1 / 6
PRO-0430-W	8719747930120	3 M track (3000mm)	<input type="checkbox"/> White	1 / 6
PRO-0430-S	8719747930137	3 M track (3000mm)	<input type="checkbox"/> Grey	1 / 6
PRO-0430-B	8719747930144	3 M track (3000mm)	<input type="checkbox"/> Black	1 / 6

3-CIRCUIT RECESSED TRACK SYSTEM

Product Code	EAN	Product description	Colour	Package
PRO-R410-W	8719747931011	1 M track (1000mm)	<input type="checkbox"/> White	1 / 4
PRO-R410-S	8719747931028	1 M track (1000mm)	<input type="checkbox"/> Grey	1 / 4
PRO-R410-B	8719747931035	1 M track (1000mm)	<input type="checkbox"/> Black	1 / 4
PRO-R420-W	8719747931042	2 M track (2000mm)	<input type="checkbox"/> White	1 / 4
PRO-R420-S	8719747931059	2 M track (2000mm)	<input type="checkbox"/> Grey	1 / 4
PRO-R420-B	8719747931066	2 M track (2000mm)	<input type="checkbox"/> Black	1 / 4
PRO-R430-W	8719747931073	3 M track (3000mm)	<input type="checkbox"/> White	1 / 4
PRO-R430-S	8719747931080	3 M track (3000mm)	<input type="checkbox"/> Grey	1 / 4
PRO-R430-B	8719747931097	3 M track (3000mm)	<input type="checkbox"/> Black	1 / 4

Simply apply the comprehensive range of innovative DALI-1 circuit accessories and a standard track is turned into a DALI version.

CONNECTOR LEFT DALI 1-CIRCUIT



Product Code	EAN	Colour	Package
PRO-D431 L-W	8719747931882	White	12 / 144
PRO-D431 L-S	8719747931899	Grey	12 / 144
PRO-D431 L-B	8719747931905	Black	12 / 144



CONNECTOR RIGHT DALI 1-CIRCUIT



Product Code	EAN	Colour	Package
PRO-D431 R-W	8719747931912	White	12 / 144
PRO-D431 R-S	8719747931929	Grey	12 / 144
PRO-D431 R-B	8719747931936	Black	12 / 144



MIDDLE CONNECTOR DALI 1-CIRCUIT



Product Code	EAN	Colour	Package
PRO-D434-W	8719747932001	White	10 / 120
PRO-D434-S	8719747932018	Grey	10 / 120
PRO-D434-B	8719747932025	Black	10 / 120



FLEXIBLE CONNECTOR DALI 1-CIRCUIT



Product Code	EAN	Colour	Package
PRO-D439-W	8719747932247	White	14 / 70
PRO-D439-S	8719747932254	Grey	14 / 70
PRO-D439-B	8719747932261	Black	14 / 70



X CONNECTOR DALI 1-CIRCUIT

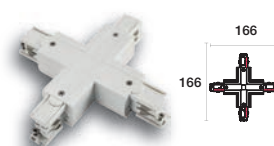

Product Code	EAN	Colour	Package
PRO-D437-W	8719747932216	White	5 / 60
PRO-D437-S	8719747932223	Grey	5 / 60
PRO-D437-B	8719747932230	Black	5 / 60



L CONNECTOR DALI LEFT 1-CIRCUIT



Product Code	EAN	Colour	Package
PRO-D435 L-W	8719747932032	White	18 / 108
PRO-D435 L-S	8719747932049	Grey	18 / 108
PRO-D435 L-B	8719747932056	Black	18 / 108



L CONNECTOR DALI RIGHT 1-CIRCUIT



Product Code	EAN	Colour	Package
PRO-D435 R-W	8719747932063	White	18 / 108
PRO-D435 R-S	8719747932070	Grey	18 / 108
PRO-D435 R-B	8719747932087	Black	18 / 108



T CONNECTOR DALI LEFT1 1-CIRCUIT

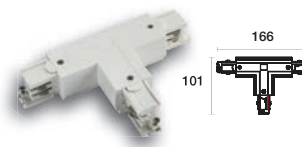

Product Code	EAN	Colour	Package
PRO-D436 L1-W	8719747932094	White	12 / 72
PRO-D436 L1-S	8719747932100	Grey	12 / 72
PRO-D436 L1-B	8719747932117	Black	12 / 72



T CONNECTOR DALI LEFT2 1-CIRCUIT

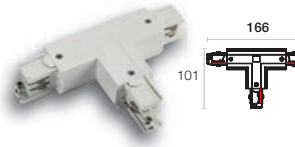

Product Code	EAN	Colour	Package
PRO-D436 L2-W	8719747932124	White	12 / 72
PRO-D436 L2-S	8719747932131	Grey	12 / 72
PRO-D436 L2-B	8719747932148	Black	12 / 72



T CONNECTOR DALI RIGHT1 1-CIRCUIT

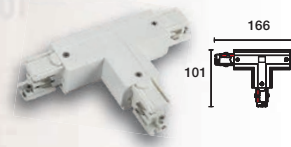

Product Code	EAN	Colour	Package
PRO-D436 R1-W	8719747932155	White	12 / 72
PRO-D436 R1-S	8719747932162	Grey	12 / 72
PRO-D436 R1-B	8719747932179	Black	12 / 72



T CONNECTOR DALI RIGHT2 1-CIRCUIT

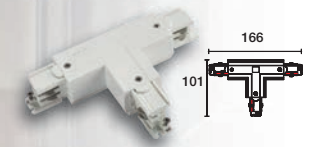

Product Code	EAN	Colour	Package
PRO-D436 R2-W	8719747932186	White	12 / 72
PRO-D436 R2-S	8719747932193	Grey	12 / 72
PRO-D436 R2-B	8719747932209	Black	12 / 72



COUPLER, ENDCAP AND CONNECTOR COVER ARE THE SAME AS FOR STANDARD 3-CIRCUIT TRACK

*Track system design
made flexible and versatile*



TRACK SUSPENSION & GENERAL ACCESSORIES

The Powergear track suspension accessories make the track system quick and easy to install. Suspension kits wire lengths can be customized. Track plans can be easily extended via fixed or DALI monopoints. And for an additional power outlet simply use the Powergear Schuko adapter

SUSPENSION CONNECTION CLAMP

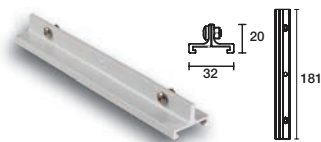

Product Code	EAN	Colour	Package
PRO-0418SK-W	8719747930847	White	6 / 180
PRO-0418SK-S	8719747930854	Grey	6 / 180
PRO-0418SK-B	8719747930861	Black	6 / 180



ROD SUSPENSION EZCLICK
suspension kit with 1m rod



Product Code	EAN	Colour	Package
PRO-EZ0447-W	8719747930755	White	1 / 30
PRO-EZ0447-S	8719747930762	Grey	1 / 30
PRO-EZ0447-B	8719747930779	Black	1 / 30



WIRE SUSPENSION EZCLICK 5M
suspension kit with 5m steel wire



Product Code	EAN	Colour	Package
PRO-EZ0449-W	8719747932483	White	8 / 96
PRO-EZ0449-S	8719747932490	Grey	8 / 96
PRO-EZ0449-B	8719747932506	Black	8 / 96



WIRE SUSPENSION EZCLICK 5M
suspension kit with 5m steel wire



Product Code	EAN	Colour	Package
PRO-EZ0448-W	8719747930786	White	8 / 96
PRO-EZ0448-S	8719747930793	Grey	8 / 96
PRO-EZ0448-B	8719747930809	Black	8 / 96



T-BAR EZCLICK



Product Code	EAN	Colour	Package
PRO-M146T-W	8719747930816	White	25 / 500
PRO-M146T-S	8719747930823	Grey	25 / 500
PRO-M146T-B	8719747930830	Black	25 / 500



REINFORCEMENT PLATE
reinforcement plate with 5m steel suspension wire



Product Code	EAN	Colour	Package
PRO-M147-W	8719747932643	White	4 / 48
PRO-M147-S	8719747932650	Grey	4 / 48
PRO-M147-B	8719747932667	Black	4 / 48



MOUNTING CLAMP



Product Code	EAN	Colour	Package
PRO-04SK-W	8719747930939	White	30 / 600
PRO-04SK-S	8719747930946	Grey	30 / 600
PRO-04SK-B	8719747930953	Black	30 / 600



SUSPENSION HOOK



Product Code	EAN	Colour	Package
PRO-M142-W	8719747930878	White	20 / 400
PRO-M142-S	8719747930885	Grey	20 / 400
PRO-M142-B	8719747930892	Black	20 / 400



TRACK COVER STRIP 3M



Product Code	EAN	Colour	Package
PRO-CS04300-W	8719747932438	White	1 / 150
PRO-CS04300-B	8719747932445	Black	1 / 150



FIXED MONOPOINT FOR TRACK ADAPTER

universal



Product Code	EAN	Colour	Package
PRO-C100-W	8719747930960	White	1 / 50
PRO-C100-S	8719747930977	Grey	1 / 50
PRO-C100-B	8719747930984	Black	1 / 50



FIXED MONOPOINT FOR DALI TRACK ADAPTER



Product Code	EAN	Colour	Package
PRO-C150-W	8719747933213	White	1 / 40
PRO-C150-S	8719747933220	Grey	1 / 40
PRO-C150-B	8719747933237	Black	1 / 40



SCHUKO ADAPTER



Product Code	EAN	Colour	Package
PRO-4230V-W	8719747930991	White	1 / 50
PRO-4230V-B	8719747931004	Black	1 / 50





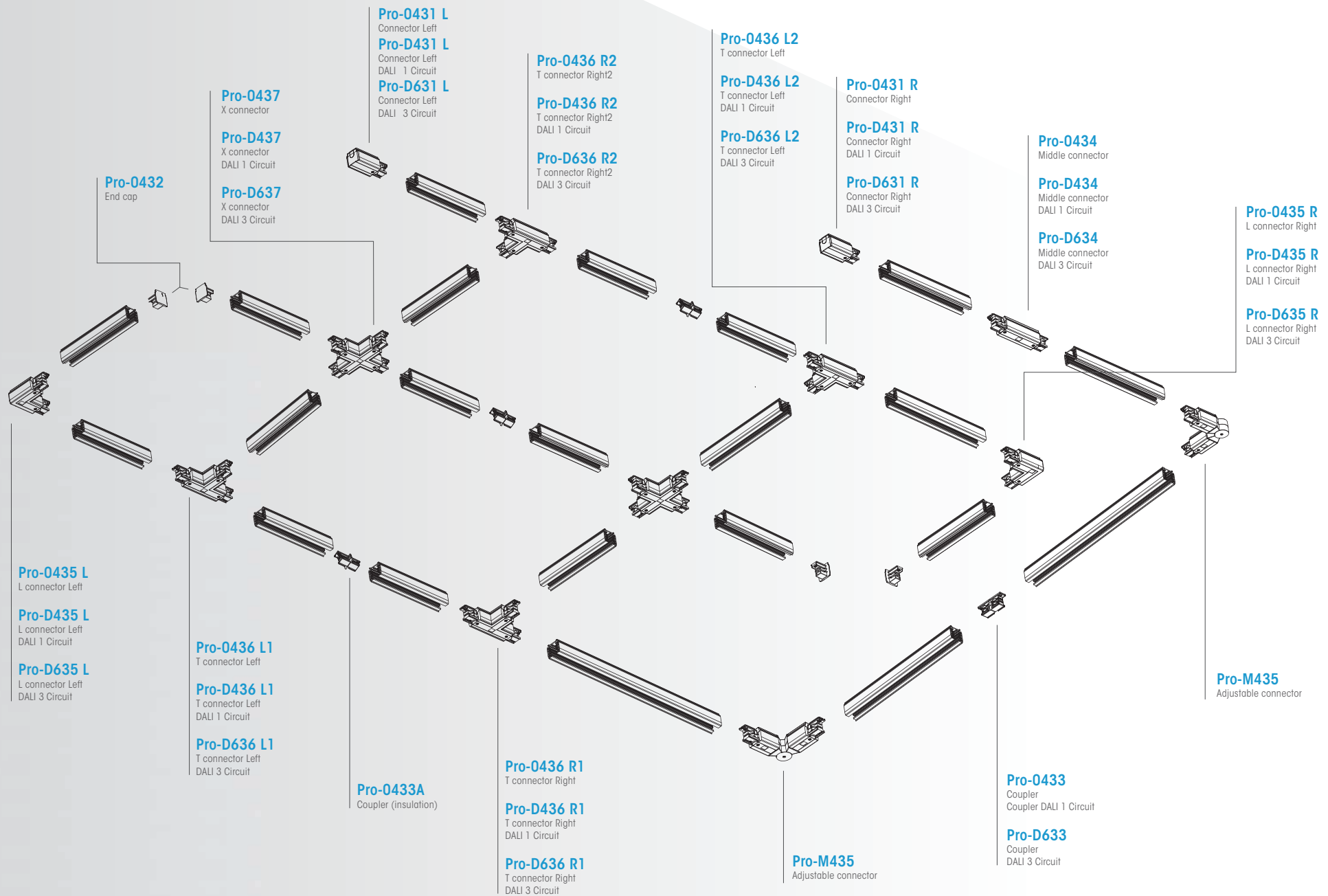

*Versatile, innovative
and highly compatible*



ADAPTER SOLUTIONS

Powergear offers a wide range of 3 circuit and 3 circuit DALI adapters for the OEM market.

Powergear adapters are highly compatible to all major lighting track systems. The innovative range of intrack adapters enable new opportunities for minimalistic design in track lights. A multi current LED driver is concealed in the adapter. To make your 3-circuit system Bluetooth controllable, Powergear offers an Ultimate adapter with Casambi technology.

SMART 3-CIRCUIT ADAPTER



Product Code	EAN	Colour	Package
PRO-0222-W	8719747930182	White	1 / 150
PRO-0222-S	8719747930199	Grey	1 / 150
PRO-0222-B	8719747930205	Black	1 / 150

FMax: 50N



CLASSIC 3-CIRCUIT ADAPTER



Product Code	EAN	Colour	Package
PRO-0440-W	8719747932346	White	1 / 150
PRO-0440-S	8719747932353	Grey	1 / 150
PRO-0440-B	8719747932360	Black	1 / 150

FMax: 100N



DALI 3-CIRCUIT ADAPTER

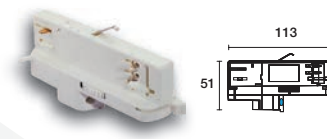

Product Code	EAN	Colour	Package
PRO-D680-W	8719747931349	White	1 / 150
PRO-D680-S	8719747931356	Grey	1 / 150
PRO-D680-B	8719747931363	Black	1 / 150

FMax: 100N

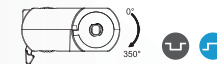

DALI 1-CIRCUIT ADAPTER



Product Code	EAN	Colour	Package
PRO-D480-W	8719747931851	White	1 / 150
PRO-D480-S	8719747931868	Grey	1 / 150
PRO-D480-B	8719747931875	Black	1 / 150

FMax: 100N



NIPPLE M10X8

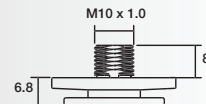

Product Code	EAN	Colour	Package
PRO-M10-008-02	8719747932315	Alu	100
PRO-M10-008-02-W	8719747932513	White	100
PRO-M10-008-02-S	8719747932674	Grey	100
PRO-M10-008-02-B	8719747932520	Black	100

NIPPLE M10X12

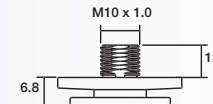

Product Code	EAN	Colour	Package
PRO-M10-012-02	8719747932322	Alu	100
PRO-M10-012-02-W	8719747932537	White	100
PRO-M10-012-02-S	8719747932681	Grey	100
PRO-M10-012-02-B	8719747932544	Black	100

PVC STRAIN RELIEF

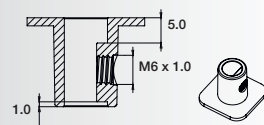

Product Code	EAN	Colour	Package
PRO-M510-W	8719747933244	White	100
PRO-M510-S	8719747933251	Grey	100
PRO-M510-B	8719747933268	Black	100

PVC NIPPLE STRAIN RELIEF M10

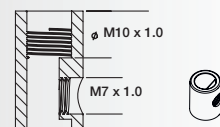

Product Code	EAN	Colour	Package
PRO-M10-008-PVC-W	8719747933152	White	100
PRO-M10-008-PVC-S	8719747933169	Grey	100
PRO-M10-008-PVC-B	8719747933176	Black	100

TOOL FOR WIRING



Product Code	EAN	Colour	Package
PRO-0222-001-04	8719747932308		1

ULTIMATE ADAPTER OSRAM^{INSIDE}

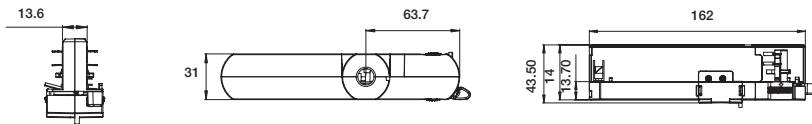

Specifications
 Flicker Free, Ripple Free
 Input: 220-240Vac, 50/60Hz
 Output: 25-42Vdc
 Current output dc/mA: Pro-UA420 / 250-500mA 11-21W
 Pro-UA430 / 600-800mA 25-34W
 Pro-UA440 / 850-1050mA 36-44W
 Dip-switches for easy output current selection
 Lifetime: 50.000 hours
 Fmax: 50N
 Certificate: ENEC/CE/CCC

Product Code	EAN	Colour	Package
PRO-UA420-W	8719747933985	White	1 / 50
PRO-UA420-S	8719747933992	Grey	1 / 50
PRO-UA420-B	8719747934005	Black	1 / 50
PRO-UA430-W	8719747934012	White	1 / 50
PRO-UA430-S	8719747934029	Grey	1 / 50
PRO-UA430-B	8719747934036	Black	1 / 50
PRO-UA440-W	8719747934043	White	1 / 50
PRO-UA440-S	8719747934050	Grey	1 / 50
PRO-UA440-B	8719747934067	Black	1 / 50

ULTIMATE ADAPTER DALI

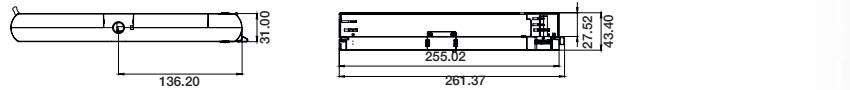

Specifications
 Flicker Free
 Input: 220-240Vac, 50/60Hz
 Output: 5-44Vdc, 59Vdc Max.
 Current output dc/mA: Pro-T6700 / 325-700mA 14-31W
 Pro-T61050 / 675-1050mA 28-40W
 PF>0.9, THD<15%
 ta: 0°C - 35°C, tc: 85°C
 Fmax: 50N
 Unloaded protection, Short-circuit Protection,
 Overvoltage Protection
 Certificate: ENEC/CE/CCC

Product Code	EAN	Colour	Package
PRO-T6700-W	8719747932612	White	1 / 50
PRO-T6700-S	8719747932629	Grey	1 / 50
PRO-T6700-B	8719747932636	Black	1 / 50
PRO-T61050-W	8719747934104	White	1 / 50
PRO-T61050-S	8719747934111	Grey	1 / 50
PRO-T61050-B	8719747934128	Black	1 / 50

ULTIMATE ADAPTER CASAMBI

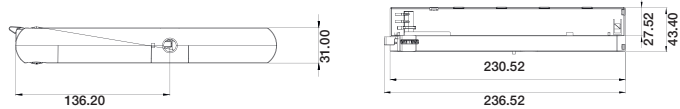

Specifications
 Flicker Free
 Input: 220-240Vac, 50/60Hz
 Output: 5-42Vdc, 59Vdc Max.
 Current output dc/mA: 325-700mA 14-31W
 PF>0.9, THD<15%
 ta: 0°C - 35°C, tc: 90°C
 Fmax: 50N
 Unloaded protection, Short-circuit Protection,
 Overvoltage Protection
 Certificate: ENEC/CE/CCC

Product Code	EAN	Colour	Package
PRO-4700CB-W	8719747934074	White	1 / 50
PRO-4700CB-S	8719747934081	Grey	1 / 50
PRO-4700CB-B	8719747934098	Black	1 / 50

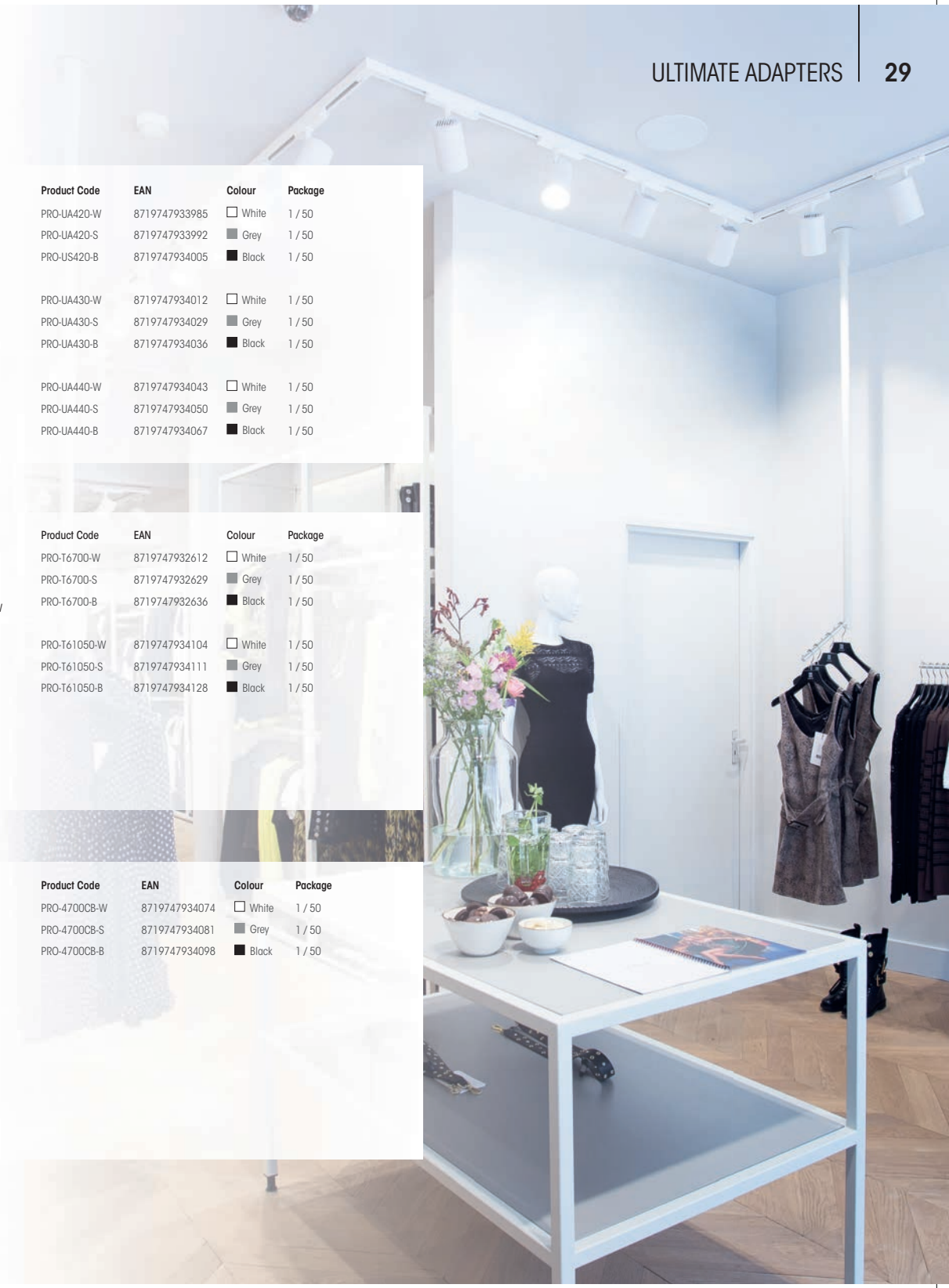

ULTIMATE ADAPTER WIDE OPERATING VOLTAGE



Specifications
 Input: 220-240Vac, 50/60Hz
 Output: 5-42Vdc, 59Vdc Max.
 Current output dc/mA: 675-1050mA 28-40W
 PF>0.9, THD<15%
 ta: 0°C - 35°C, tc: 90°C
 Fmax: 50N
 Unloaded protection, Short-circuit Protection,
 Overvoltage Protection
 Certificate: ENEC/CE/CCC

Product Code	EAN	Colour	Package
PRO-41050-W	8719747932582	White	5 / 50
PRO-41050-S	8719747932599	Grey	5 / 50
PRO-41050-B	8719747932605	Black	5 / 50

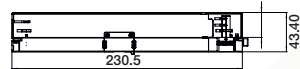
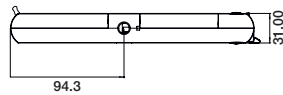

ULTIMATE ADAPTER TRIAC DIMMABLE



Specifications
 Input: 220-240Vac, 50/60Hz
 Output: 25-40Vdc
 Current output dc/mA: 350mA, 500mA, 750mA
 Fmax: 50N
 Certificate: ENEC/CE/CCC

RELEASE IN 2021
 PLEASE CHECK WEBSITE

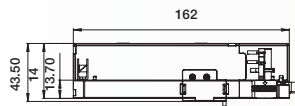
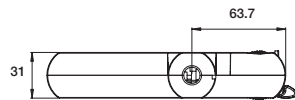



*The miniaturized alternative,
flexible and elegant*





48V TRACK SYSTEM

The high quality Powergear 48V lighting track system for the professional lighting market is suitable for track lights with Powergear 48V adapters.

Whether for aesthetical or technical reasons e.g. in residential, high end retail or museum projects, Powergear's 48V lighting track system is ideal in cases where subtle designs are required.

A comprehensive range of innovative accessories and a multitude of different ultimate adapters, give designers maximum freedom to create unique and smart 48V lighting track plans.

Powergear 48V lighting track systems come in various surface mounted as well as recessed versions. The "EZCLICK" mounting features complete the system and make the track system quick and easy to install for suspended solutions.

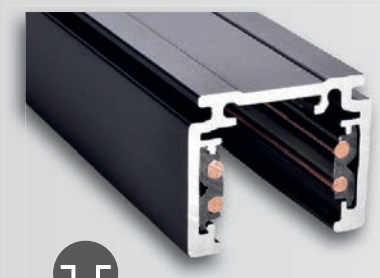

SURFACE MOUNTED

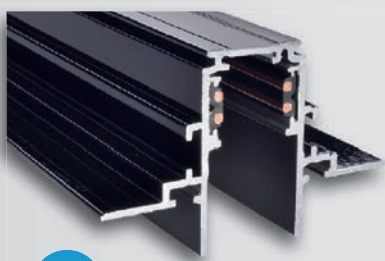
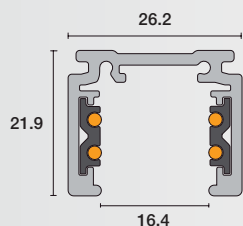

RECESSED

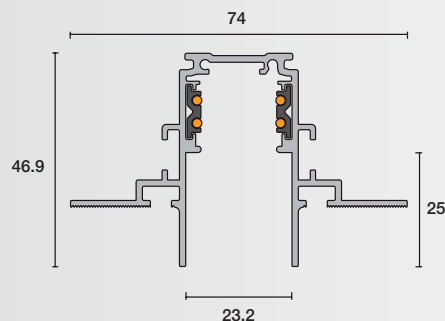

SURFACE MOUNTED

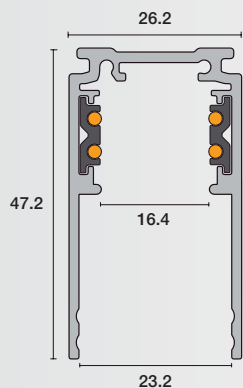

48V SURFACE MOUNTED TRACK SYSTEM

Product Code	EAN	Product description	Colour	Package
PRO-N110-B	8719747934135	1 M track (1000mm)	■ Black	N/A
PRO-N120-B	8719747934142	2 M track (2000mm)	■ Black	N/A
PRO-N130-B	8719747934159	3 M track (3000mm)	■ Black	N/A
PRO-N110-W	8719747934760	1 M track (1000mm)	□ White	N/A
PRO-N120-W	8719747934777	2 M track (2000mm)	□ White	N/A
PRO-N130-W	8719747934784	3 M track (3000mm)	□ White	N/A

48V RECESSED TRACK SYSTEM

Product Code	EAN	Product description	Colour	Package
PRO-RN110-B	8719747934586	1 M track (1000mm)	■ Black	N/A
PRO-RN120-B	8719747934593	2 M track (2000mm)	■ Black	N/A
PRO-RN130-B	8719747934609	3 M track (3000mm)	■ Black	N/A
PRO-RN110-W	8719747934791	1 M track (1000mm)	□ White	N/A
PRO-RN120-W	8719747934807	2 M track (2000mm)	□ White	N/A
PRO-RN130-W	8719747934814	3 M track (3000mm)	□ White	N/A

48V SURFACE MOUNTED DEEP TRACK SYSTEM

Product Code	EAN	Product description	Colour	Package
PRO-DN110-B	8719747934821	1 M track (1000mm)	■ Black	N/A
PRO-DN120-B	8719747934838	2 M track (2000mm)	■ Black	N/A
PRO-DN130-B	8719747934845	3 M track (3000mm)	■ Black	N/A
PRO-DN110-W	8719747934852	1 M track (1000mm)	□ White	N/A
PRO-DN120-W	8719747934869	2 M track (2000mm)	□ White	N/A
PRO-DN130-W	8719747934876	3 M track (3000mm)	□ White	N/A

More technical details on page 43.

LIVE END CONNECTOR LEFT POLARIZED



Product Code	EAN	Colour	Package
PRO-N131L-B	8719747934166	Black	N/A
PRO-N131L-W	8719747934883	White	N/A



LIVE END CONNECTOR RIGHT POLARIZED



Product Code	EAN	Colour	Package
PRO-N131R-B	8719747934906	Black	N/A
PRO-N131R-W	8719747934913	White	N/A



END CAP



Product Code	EAN	Colour	Package
PRO-N132-B	8719747934180	Black	N/A
PRO-N132-W	8719747934982	White	N/A



RECESSED END CAP

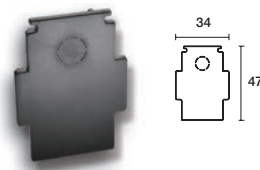

Product Code	EAN	Colour	Package
PRO-RN132-B	8719747934197	Black	N/A
PRO-RN132-W	8719747934999	White	N/A



DEEP PROFILE END CAP

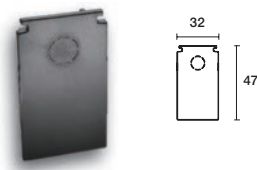

Product Code	EAN	Colour	Package
PRO-DN132-B	8719747935002	Black	N/A
PRO-DN132-W	8719747935019	White	N/A



FLEXIBLE CONNECTOR



Product Code	EAN	Colour	Package
PRO-N139-B	8719747934203	Black	N/A
PRO-N139-W	8719747935026	White	N/A



I CONNECTOR



Product Code	EAN	Colour	Package
PRO-N133-B	8719747934210	Black	N/A
PRO-N133-W	8719747935033	White	N/A



L CONNECTOR



Product Code	EAN	Colour	Package
PRO-N135L-B	8719747934227	Black	N/A
PRO-N135L-W	8719747935040	White	N/A



L-PROFILE CONNECTOR-FLAT LEFT

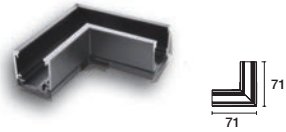

Product Code	EAN	Colour	Package
PRO-N135FL-B	8719747934234	■ Black	N / A
PRO-N135FL-W	8719747935057	□ White	N / A



L-PROFILE CONNECTOR-FLAT RIGHT

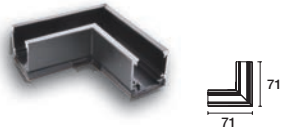

Product Code	EAN	Colour	Package
PRO-N135FR-B	8719747935453	■ Black	N / A
PRO-N135FR-W	8719747935460	□ White	N / A



L RECESSED PROFILE CONNECTOR-FLAT LEFT

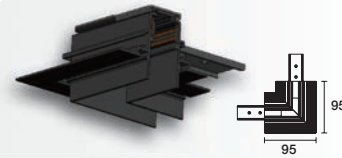

Product Code	EAN	Colour	Package
PRO-RN135FL-B	8719747934291	■ Black	N / A
PRO-RN135FL-W	8719747935064	□ White	N / A



L RECESSED PROFILE CONNECTOR-FLAT RIGHT

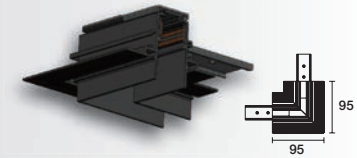

Product Code	EAN	Colour	Package
PRO-RN135FR-B	8719747935477	■ Black	N / A
PRO-RN135FR-W	8719747935484	□ White	N / A



L DEEP PROFILE CONNECTOR-FLAT LEFT

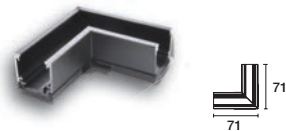

Product Code	EAN	Colour	Package
PRO-DN135FL-B	8719747935491	■ Black	N / A
PRO-DN135FL-W	8719747935507	□ White	N / A



L DEEP PROFILE CONNECTOR-FLAT RIGHT

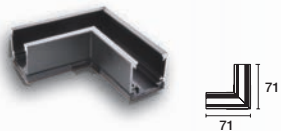

Product Code	EAN	Colour	Package
PRO-DN135FR-B	8719747935514	■ Black	N / A
PRO-DN135FR-W	8719747935521	□ White	N / A



L PROFILE CONNECTOR-STEREO

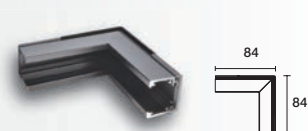

Product Code	EAN	Colour	Package
PRO-N135S-B	8719747934258	■ Black	N / A
PRO-N135S-W	8719747935071	□ White	N / A



L RECESSED PROFILE CONNECTOR-STEREO



Product Code	EAN	Colour	Package
PRO-RN135S-B	8719747934265	■ Black	N / A
PRO-RN135S-W	8719747935088	□ White	N / A



L DEEP PROFILE CONNECTOR-STEREO

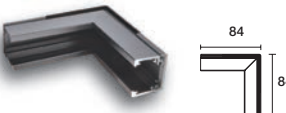

Product Code	EAN	Colour	Package
PRO-DN135S-B	8719747935538	■ Black	N / A
PRO-DN135S-W	8719747935545	□ White	N / A



CEILING MOUNT EZ CLICK WITH ROD



Product Code	EAN	Colour	Package
PRO-EZN147-B	8719747934326	■ Black	N / A
PRO-EZN147-W	8719747935095	□ White	N / A



CEILING MOUNT EZ CLICK WITH WIRE



Product Code	EAN	Colour	Package
PRO-EZN148-B	8719747934333	■ Black	N / A
PRO-EZN148-W	8719747935101	□ White	N / A



CEILING MOUNT REINFORCEMENT WITH ROD



Product Code	EAN	Colour	Package
PRO-N147-B	8719747934364	■ Black	N / A
PRO-N147-W	8719747935118	□ White	N / A



CEILING MOUNT REINFORCEMENT WITH WIRE



Product Code	EAN	Colour	Package
PRO-N148-B	8719747934371	■ Black	N/A
PRO-N148-W	8719747935125	□ White	N/A



TRACK COVER STRIP

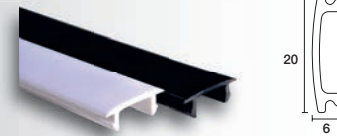

Product Code	EAN	Colour	Package
PRO-CSN01-B	8719747934395	■ Black	N/A
PRO-CSN01-W	8719747935149	□ White	N/A



48V ULTIMATE ADAPTERS WITH MECHANICAL LOCK

48V ADAPTER EXCLUDING LED DRIVER / DOUBLE HEAD POLARIZED



PRO-N140A

PRO-N140B

Specifications
Fmax: 10N

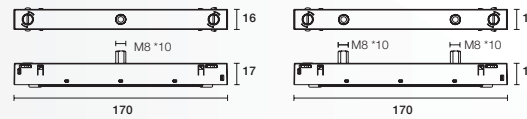

Product Code	EAN	Colour	Package
PRO-N140A-B	8719747934272	■ Black	N/A
PRO-N140A-W	8719747935156	□ White	N/A
PRO-N140A-B	8719747934388	■ Black	N/A
PRO-N140A-W	8719747935163	□ White	N/A

48V ADAPTER INCLUDING ON/OFF LED DRIVER / DOUBLE HEAD POLARIZED



PRO-N140A-OO

PRO-N140B-OO

Specifications

Adapter including on/off LED driver
Output: 6-40V
Current output DC/mA: 250-1000mA
Dip-switches for easy output current selection
Lifetime: 50.000 hours
Fmax: 10N



Product Code	EAN	Colour	Package
PRO-N140A-OO-B	8719747935170	■ Black	N/A
PRO-N140A-OO-W	8719747935187	□ White	N/A
PRO-N140A-OO-B	8719747935194	■ Black	N/A
PRO-N140A-OO-W	8719747935200	□ White	N/A

48V ADAPTER INCLUDING DIMMABLE 0-10V LED DRIVER POLARIZED



Specifications

Adapter including dimmable 0-10V LED driver
Output: 6-40V
Current output DC/mA: 250-1000mA
Dip-switches for easy output current selection
Lifetime: 50.000 hours
Fmax: 10N



Product Code	EAN	Colour	Package
PRO-N140A 010V-B	8719747935217	■ Black	N/A
PRO-N140A 010V-W	8719747935224	□ White	N/A

48V ADAPTER INCLUDING DIMMABLE DALI LED DRIVER POLARIZED



Specifications

Adapter including dimmable DALI LED driver
Output: 3-40V
Current output DC/mA: 350-500-700mA
Dip-switches for easy output current selection
Lifetime: 50.000 hours
Fmax: 10N



Product Code	EAN	Colour	Package
350mA current output dc			
PRO-N140A-D350-B	8719747935231	■ Black	N/A
PRO-N140A-D350-W	8719747935248	□ White	N/A
500mA current output dc			
PRO-N140A-D500-B	8719747935354	■ Black	N/A
PRO-N140A-D500-W	8719747935361	□ White	N/A
700mA current output dc			
PRO-N140A-D700-B	8719747935378	■ Black	N/A
PRO-N140A-D700-W	8719747935385	□ White	N/A

48V ULTIMATE ADAPTERS CLICK-IN

48V CLICK-IN ADAPTER EXCLUDING LED DRIVER POLARIZED / DOUBLE HEAD POLARIZED



48V CLICK-IN ADAPTER INCLUDING ON/OFF LED DRIVER POLARIZED / DOUBLE HEAD POLARIZED



48V CLICK-IN ADAPTER INCLUDING DIMMABLE 0-10V LED DRIVER POLARIZED



Specifications
 Adapter including dimmable 0-10V LED driver
 Output: 6-40V
 Current output DC/mA: 250-1000mA
 Dip-switches for easy output current selection
 Lifetime: 50.000 hours
 Fmax: 10N



Product Code	EAN	Colour	Package
PRO-MN140A 010V-B	8719747935316	Black	N / A
PRO-MN140A 010V-W	8719747935323	White	N / A

Specifications
 Fmax: 10N

Product Code	EAN	Colour	Package
PRO-MN140A-B	8719747935132	Black	N / A
PRO-MN140A-W	8719747935255	White	N / A
PRO-MN140B-B	8719747935552	Black	N / A
PRO-MN140B-W	8719747935262	White	N / A

Specifications

Adapter including on/off LED driver
 Output: 6-40V
 Current output DC/mA: 250-1000mA
 Dip-switches for easy output current selection
 Lifetime: 50.000 hours
 Fmax: 10N



Product Code	EAN	Colour	Package
PRO-MN140A-OO-B	8719747935279	Black	N / A
PRO-MN140A-OO-W	8719747935286	White	N / A
PRO-MN140B-OO-B	8719747935293	Black	N / A
PRO-MN140B-OO-W	8719747935309	White	N / A

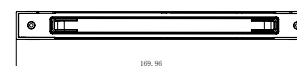

48V CLICK-IN ADAPTER INCLUDING DIMMABLE DALI LED DRIVER POLARIZED



Specifications
 Adapter including dimmable DALI LED driver
 Output: 3-40V
 Current output DC/mA: 350-500-700mA
 Dip-switches for easy output current selection
 Lifetime: 50.000 hours
 Fmax: 10N



Product Code	EAN	Colour	Package
350mA current output dc			
PRO-MN140A-D350-B	8719747935330	Black	N / A
PRO-MN140A-D350-W	8719747935347	White	N / A
500mA current output dc			
PRO-MN140A-D500-B	8719747935392	Black	N / A
PRO-MN140A-D500-W	8719747935408	White	N / A
700mA current output dc			
PRO-MN140A-D700-B	8719747935415	Black	N / A
PRO-MN140A-D700-W	8719747935422	White	N / A

MECHANICAL LOAD DIAGRAM

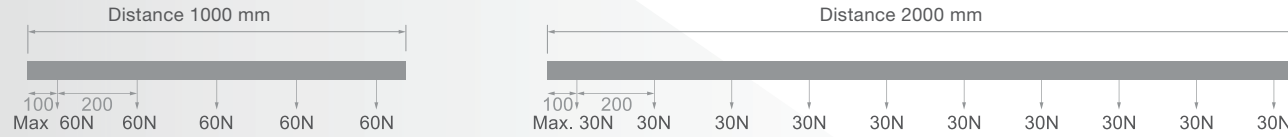

FIXING POINT DIMENSIONS

L / mm	a / mm	b / mm	c / mm	d / mm
1000	125			
2000	125	998		
3000	125		914	1167

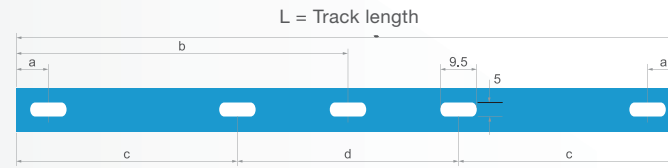

It is recommended to fasten the track at every hole with a screw or suspension kit.

CONNECTING DIAGRAM

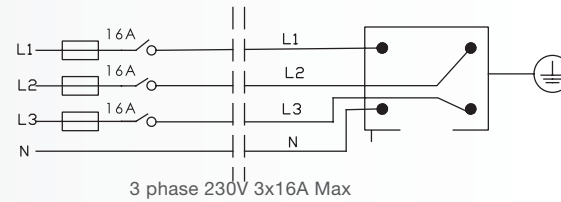
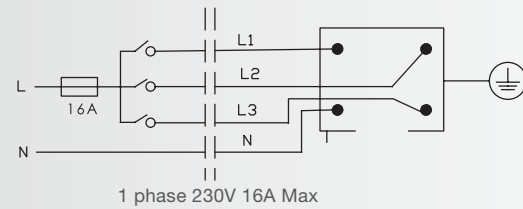

CONNECTING DIAGRAM (RED LINE INDICATES THE POLARITY RIDGE.)

FLOOR VIEW

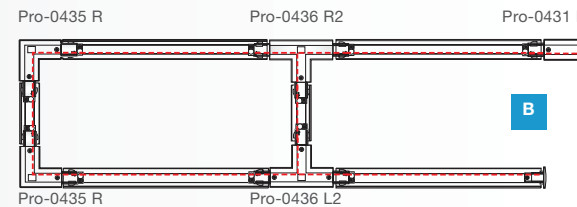
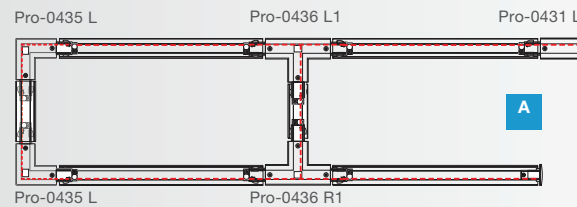

MECHANICAL LOAD DIAGRAM

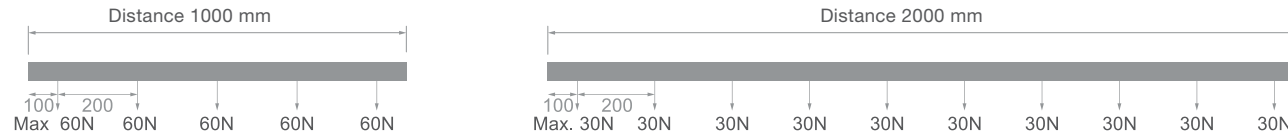

FIXING POINT DIMENSIONS

L / mm	a / mm	b / mm	c / mm	d / mm
1000	125			
2000	125	998		
3000	125		914	1167

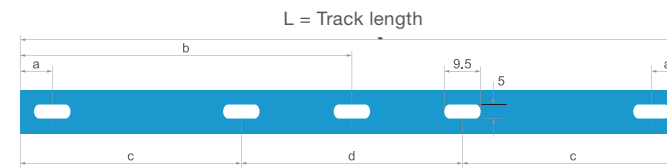

It is recommended to fasten the track at every hole with a screw or suspension kit.

CONNECTING DIAGRAM

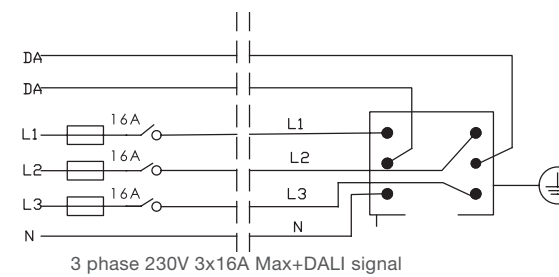
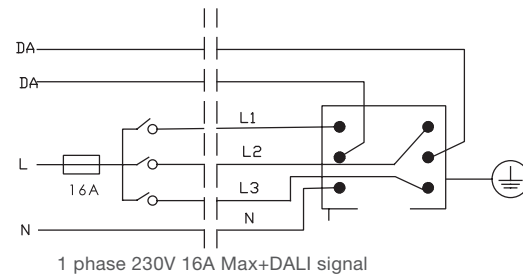

CONNECTING DIAGRAM (RED LINE INDICATES THE POLARITY RIDGE.)

FLOOR VIEW

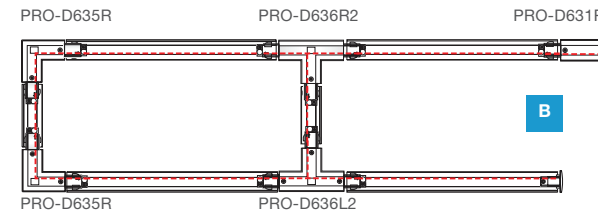
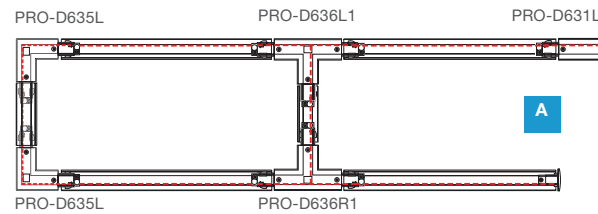

MECHANICAL LOAD DIAGRAM

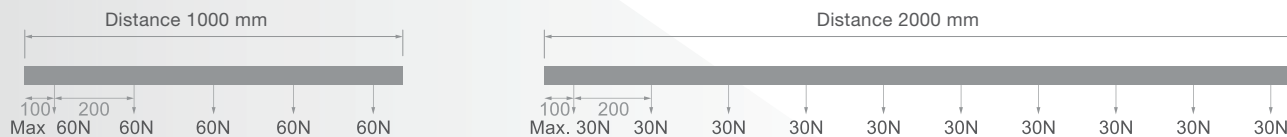

FIXING POINT DIMENSIONS

L / mm	a / mm	b / mm	c / mm	d / mm
1000	125			
2000	125	998		
3000	125		914	1167

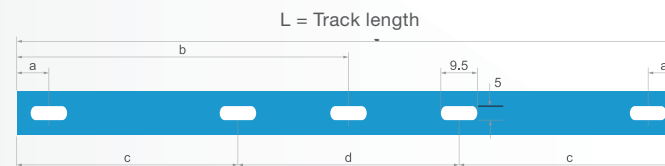

It is recommended to fasten the track at every hole with a screw or suspension kit.

CONNECTING DIAGRAM

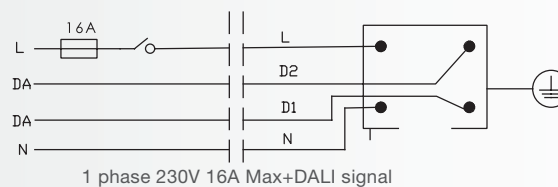

CONNECTING DIAGRAM (RED LINE INDICATES THE POLARITY RIDGE.)

FLOOR VIEW

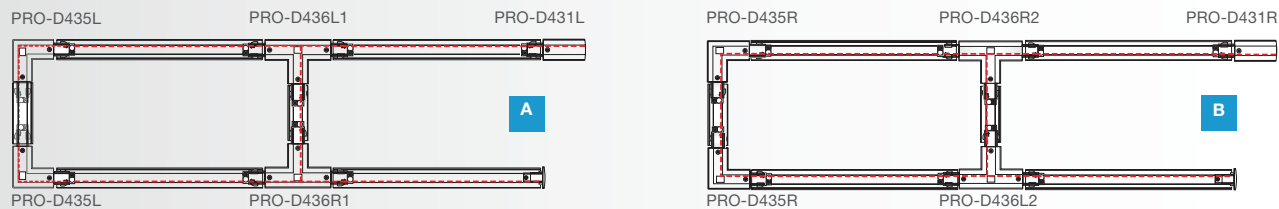

Low Voltage 2 Circuits



48V 2*15A Max.

Low Voltage Single Circuit DALI



48V 15A Max.

T-BAR EZCLICK

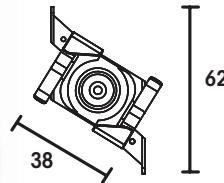

Product Code	EAN	Colour	Package
PRO-M146T-W	8719747930816	□ White	25 / 500
PRO-M146T-S	8719747930823	■ Grey	25 / 500
PRO-M146T-B	8719747930830	■ Black	25 / 500

T-BAR EZCLICK MOUNTING INSTRUCTION

1 Adjust the EZCLICK Mounting Kit's direction, put it vertically on to the T-Bar ceiling, and then rotate right and fix (as picture shows).

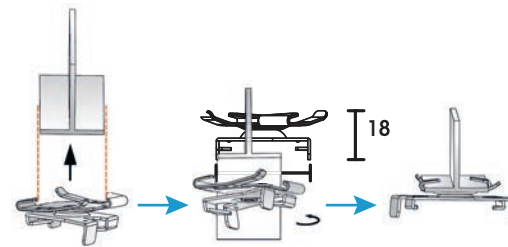

2 Adjust the EZCLICK Mounting Kit's direction, put the track vertically into the EZCLICK Mounting Kit, rotate left and fix (as picture shows)

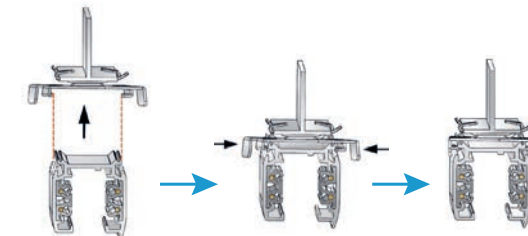

REINFORCEMENT PLATE
REINFORCEMENT PLATE WITH 5M STEEL SUSPENSION WIRE

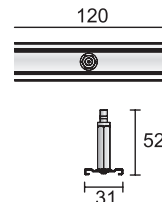

Product Code	EAN	Colour	Package
PRO-M147-W	8719747932643	□ White	4 / 48
PRO-M147-S	8719747932650	■ Grey	4 / 48
PRO-M147-B	8719747932667	■ Black	4 / 48

REINFORCEMENT PLATE MOUNTING INSTRUCTION

1 Put the track into the reinforcement plate parallel (as picture shows)

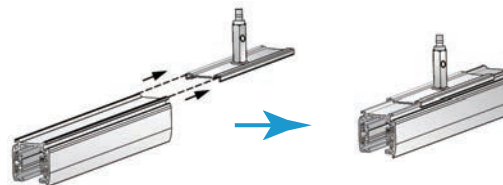

2 Release the start valve, press and get the wire through the EZCLICK mounting kit, rotate tight the start valve and lock the wirerope (as picture shows)

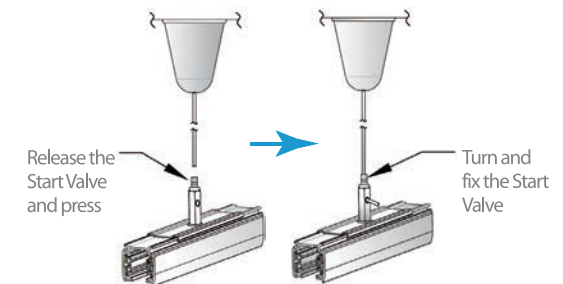

POWERGEAR EUROPE | PREMIUM DEALERS



Internova Professional Lighting BV

Rithmeesterpark 21
4838 GZ Breda
The Netherlands
T: +31 76 520 5566
E: info@internovalighting.com

Barthelme Schweiz GmbH

Steinackerstrasse 10
8902 Urdorf
Switzerland
T: +41 438 187 101
E: info@barthelme.ch

ILUMIX light s.r.o.

Holečkova 368/4
360 17 Karlovy Vary
Czech Republic
T: +420 773 900 590
E: info@ilumix.cz

Performance in Lighting

Estrada da Circunvalacao 3358
4435-186 Rio Tinto
Portugal
T: +35 1229 770 600
E: geral@morgadocl.pt

Performance in Lighting España, S.A.

Pol. Ind. La Llana
c/ Pont de Can claverí, 58
08191 Rubí (Barcelona), Spain
T: +34 93 699 5554
E: info.es@pil.lighting

Delta Lum SARK

411 Avenue du Prado Parc E2
13008 Marseille
France
T: +33 76 9625 101
E: manuel.correia@deltalum.com

Enigma Lighting

45 Woolmer Way
GU35 9QE Bordon
United Kingdom
T: +44 1420 473 889
E: sales@enigmalighting.com

Digimax SRL

Via dei Laghi 31
36077 Altavilla Vicentina
Italy
T: +39 0444 574066
E: digimax@digimax.it

Høfft ApS

Baretten 43
DK-4100, Ringsted
Denmark
+45 22 32 15 25
E: an@hofft.net